

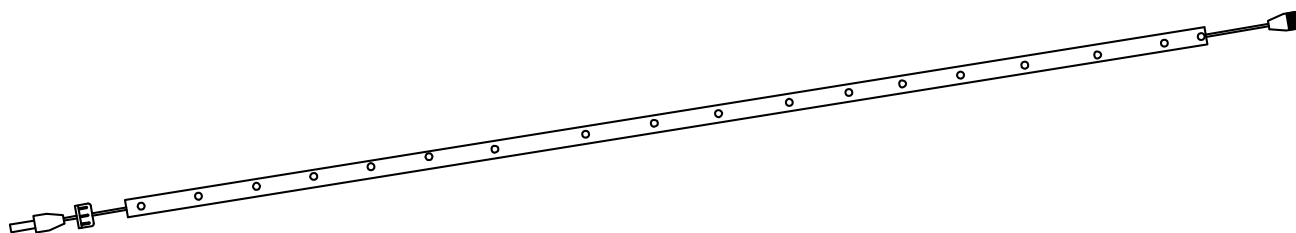

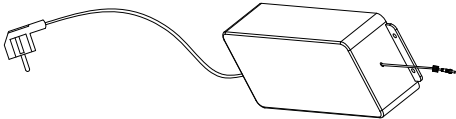





MONTERINGSANVISNING LED-BELYSNING TIL VEGGMONTERT PERGOLA 3x3m



INNHOOLDSLISTE

DELENR.	NAVN	SKISSE	ANTALL
1	12V Strøm-adapter m/ støpsel		1
2	LED Kontroller		1
3	LED Lysstripe		3
4	Lysstripe-deksel		3
5	Brakett til Lysstripe		6
6	Skrue til Lysstripe		6
7	Gjennomsiktig Plastplate		24
8	Selvborrende Skruer	 ST4. 2*25	2
9	Fjernkontroll		1

For å skjule sammenkoblingene mest mulig er det en fordel å montere lysstripene før pergolaen sammenmonteres. Men LED-lyset kan også monteres på en ferdig montert pergola.

1. Monter LED lysstripen på fremre bjelke (C2).

Press på plass de gjennomsiktige plastplatene med avstand på 20-25 cm.

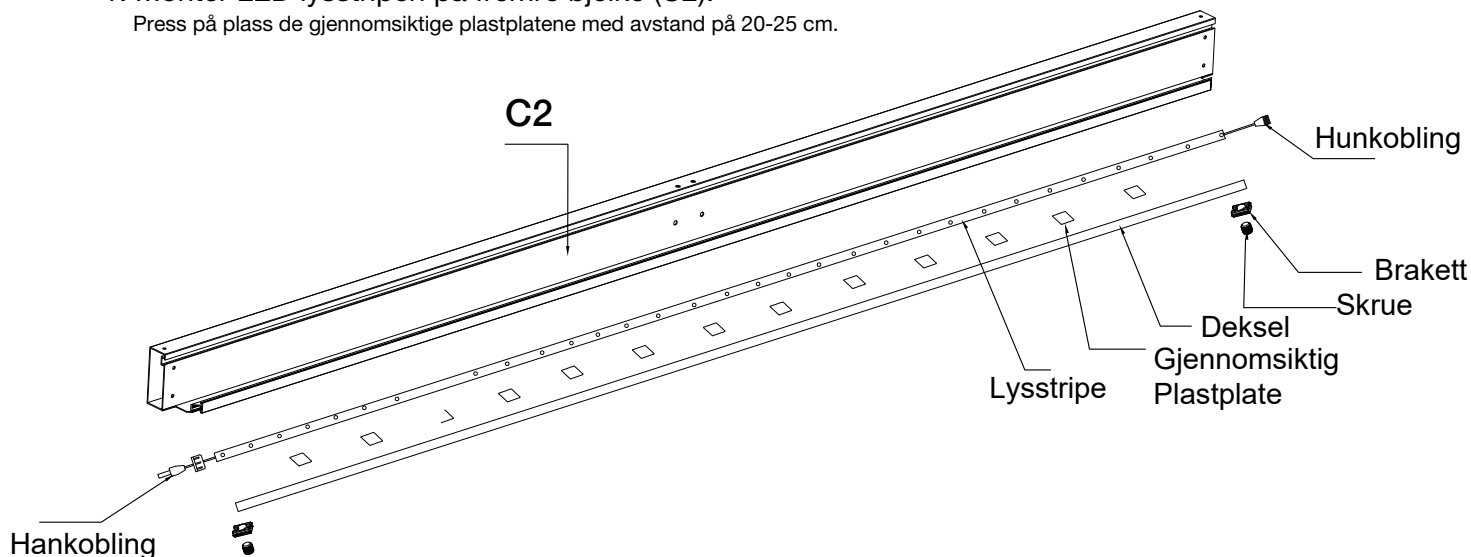

2. Monter LED lysstripen på høyre bjelke (B2).

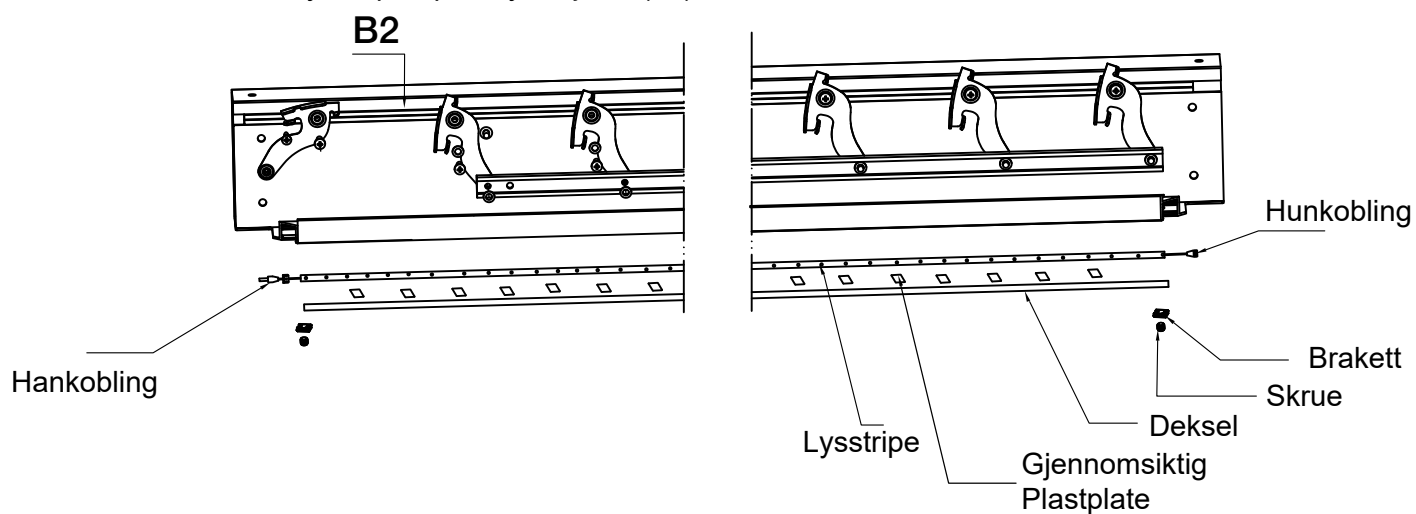

3. Monter LED lysstripen på venstre bjelke (B1).

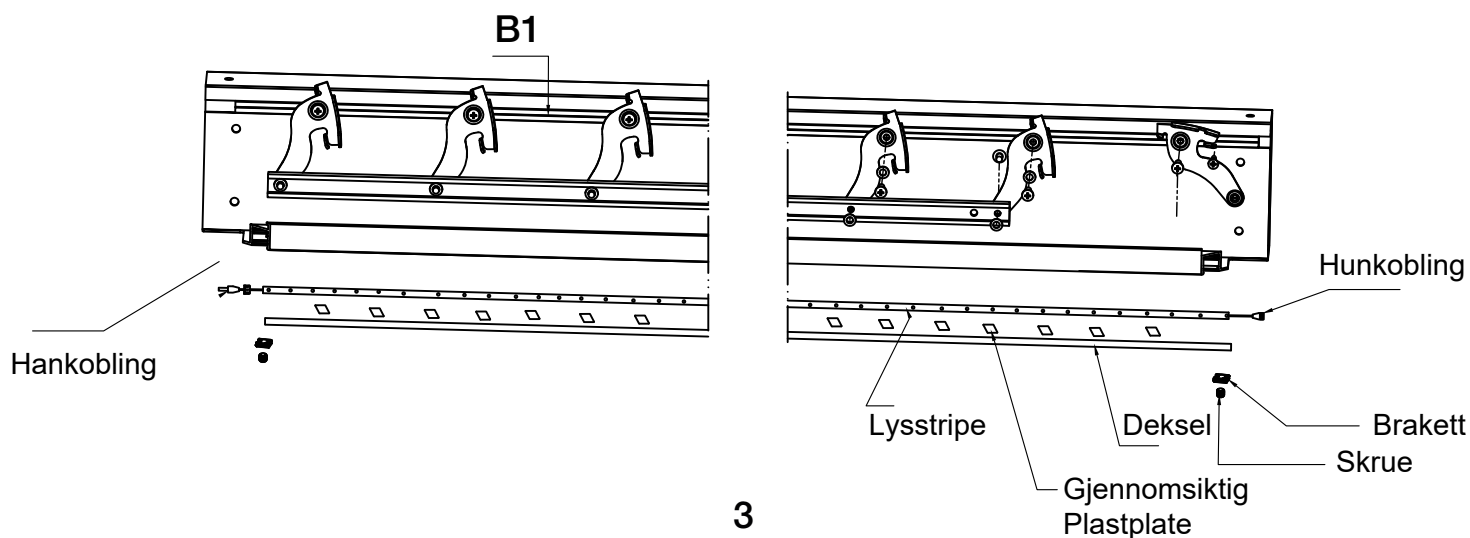

KOBLE LED- LYSET

5. Koble sammen Strømadapter (1) og LED-Kontroller (2).

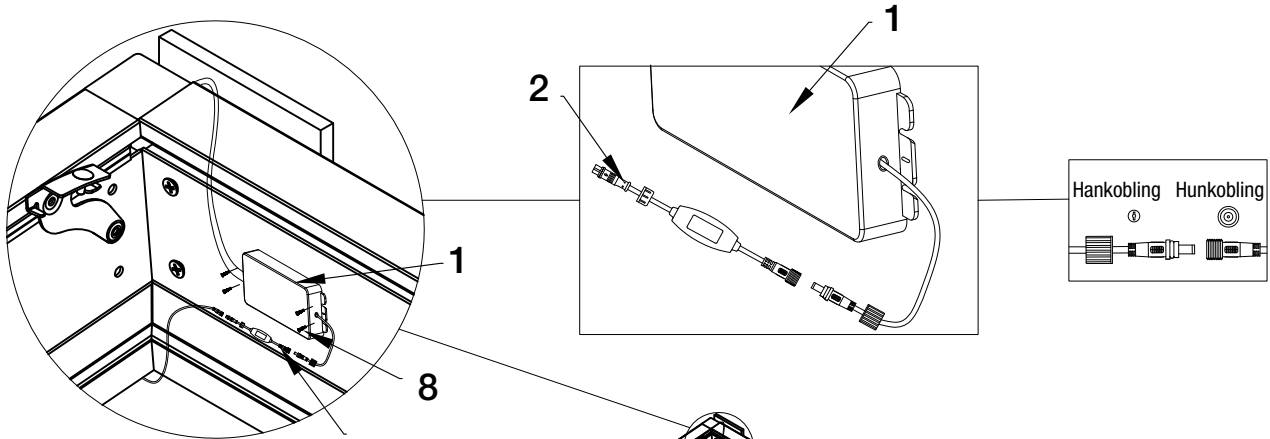

6. Fest Strømadapteren (1) på bjelke (C1) med skruer (8). Pass på at ledningene ikke blir liggende i dreneringskanalen. Juster lyset med fjernkontroll (9) etter ferdig montering.

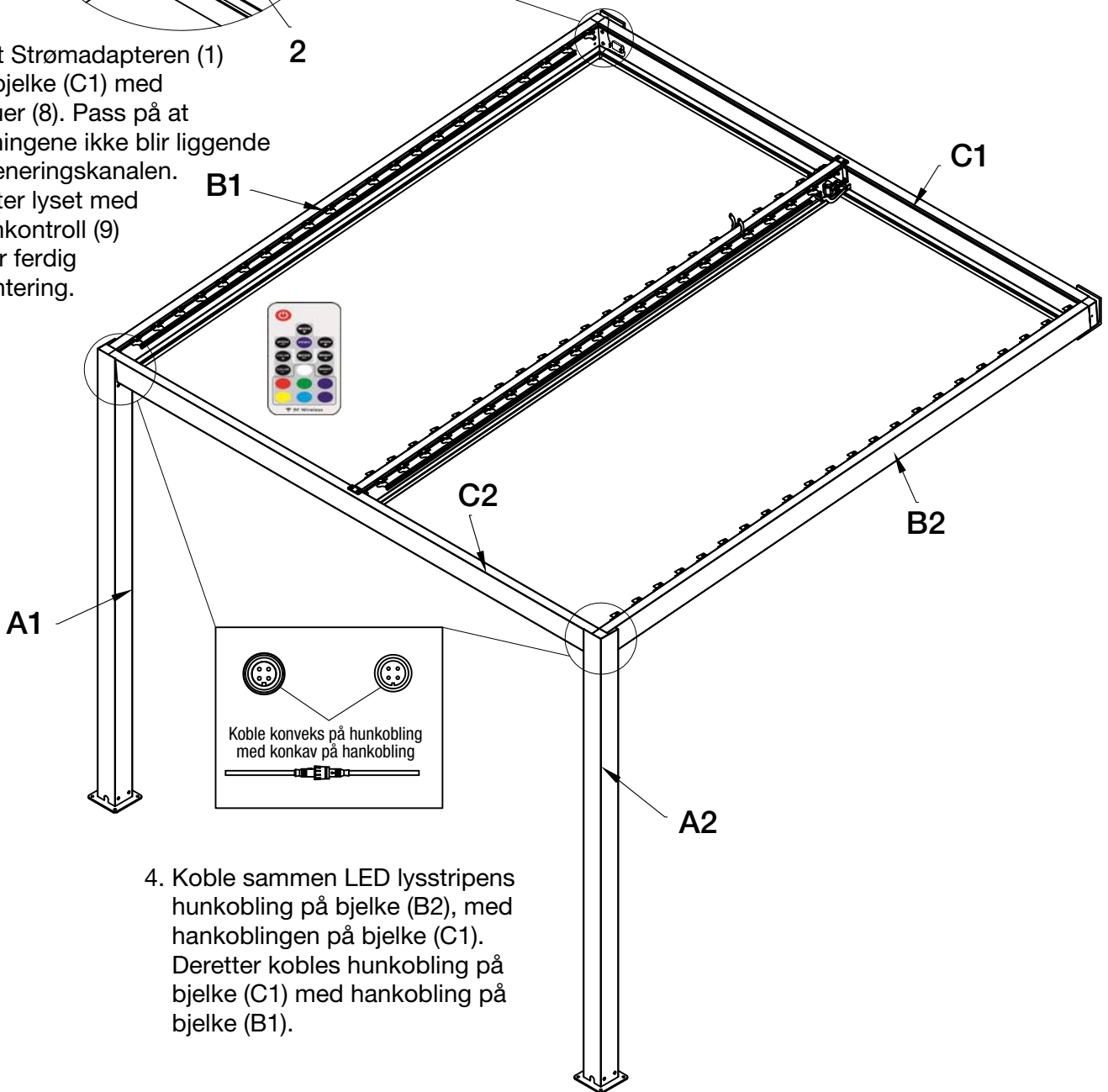

4. Koble sammen LED lysstripens hunkobling på bjelke (B2), med hankoblingen på bjelke (C1). Deretter kobles hunkobling på bjelke (C1) med hankobling på bjelke (B1).

<p>9</p>  <p>1 stk</p>	<p>8</p>  <p>2 stk</p>
---	--